

### Features

- High speed switching
- Low on-resistance
- No secondary breakdown
- Low driving power
- Avalanche-proof

### Applications

- Switching regulators
- UPS (Uninterruptible Power Supply)
- DC-DC converters

### Maximum ratings and characteristic Absolute maximum ratings

(Tc=25°C unless otherwise specified)

Item	Symbol	Ratings	Unit
Drain-source voltage	V <sub>DS</sub>	500	V
Continuous drain current	I <sub>D</sub>	±12	A
Pulsed drain current	I <sub>D(puls)</sub>	±48	A
Gate-source voltage	V <sub>GS</sub>	±30	V
Repetitive or non-repetitive	IAR *2	12	A
Maximum Avalanche Energy	EAS *1	217	mJ
Maximum Drain-Source dV/dt	dV <sub>DS</sub> /dt	20	kV/μs
Peak Diode Recovery dV/dt	dV/dt *3	5	kV/μs
Max. power dissipation	P <sub>D</sub>	T <sub>a</sub> =25°C	2.02
		T <sub>c</sub> =25°C	95
Operating and storage temperature range	T <sub>ch</sub>	+150	°C
	T <sub>stg</sub>	-55 to +150	°C

\*1 L=2.77mH, V<sub>CC</sub>=50V \*2 T<sub>ch</sub>≤150°C \*3 I<sub>F</sub>≤-I<sub>D</sub>, -di/dt=50A/μs, V<sub>CC</sub>≤BV<sub>DSS</sub>, T<sub>ch</sub>≤150°C

### Electrical characteristics (Tc =25°C unless otherwise specified)

Item	Symbol	Test Conditions	Min.	Typ.	Max.	Units
Drain-source breakdown voltage	V <sub>(BR)DSS</sub>	I <sub>D</sub> =250μA V <sub>GS</sub> =0V	500			V
Gate threshold voltage	V <sub>GS(th)</sub>	I <sub>D</sub> =250μA V <sub>DS</sub> =V <sub>GS</sub>	3.0		5.0	V
Zero gate voltage drain current	I <sub>DSS</sub>	V <sub>DS</sub> =500V V <sub>GS</sub> =0V			25	μA
		V <sub>DS</sub> =400V V <sub>GS</sub> =0V			250	
Gate-source leakage current	I <sub>GSS</sub>	V <sub>GS</sub> =±30V V <sub>DS</sub> =0V		10	100	nA
Drain-source on-state resistance	R <sub>DS(on)</sub>	I <sub>D</sub> =6A V <sub>GS</sub> =10V		0.40	0.52	Ω
Forward transconductance	g <sub>fs</sub>	I <sub>D</sub> =6A V <sub>DS</sub> =25V	5.5	11		S
Input capacitance	C <sub>iss</sub>	V <sub>DS</sub> =25V		1200	1800	pF
Output capacitance	C <sub>oss</sub>	V <sub>GS</sub> =0V		140	210	
Reverse transfer capacitance	C <sub>rss</sub>	f=1MHz		6.0	9.0	
Turn-on time t <sub>on</sub>	td(on)	V <sub>CC</sub> =300V I <sub>D</sub> =6A		17	26	ns
	t <sub>r</sub>	V <sub>GS</sub> =10V		15	23	
Turn-off time t <sub>off</sub>	td(off)	R <sub>GS</sub> =10 Ω		34	51	
	t <sub>f</sub>			7	11	
Total Gate Charge	Q <sub>G</sub>	V <sub>CC</sub> =250V		30	45	nC
Gate-Source Charge	Q <sub>GS</sub>	I <sub>D</sub> =12A		11	16.5	
Gate-Drain Charge	Q <sub>GD</sub>	V <sub>GS</sub> =10V		10	15	
Avalanche capability	I <sub>AV</sub>	L=2.77mH T <sub>ch</sub> =25°C	12			A
Diode forward on-voltage	V <sub>SD</sub>	I <sub>F</sub> =12A V <sub>GS</sub> =0V T <sub>ch</sub> =25°C		1.00	1.50	V
Reverse recovery time	t <sub>rr</sub>	I <sub>F</sub> =12A V <sub>GS</sub> =0V		0.7		μs
Reverse recovery charge	Q <sub>rr</sub>	-di/dt=100A/μs T <sub>ch</sub> =25°C		4.5		μC

### Thermal characteristics

Item	Symbol	Test Conditions	Min.	Typ.	Max.	Units
Thermal resistance	R <sub>th(ch-c)</sub>	channel to case			1.32	°C/W
	R <sub>th(ch-a)</sub>	channel to ambient			62.0	°C/W

### Outline Drawings

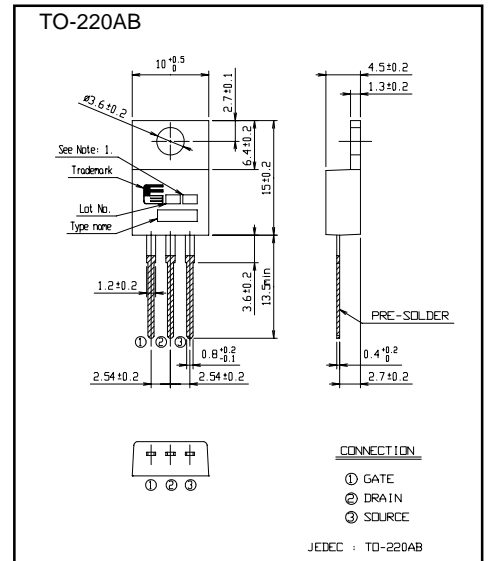

### Equivalent circuit schematic

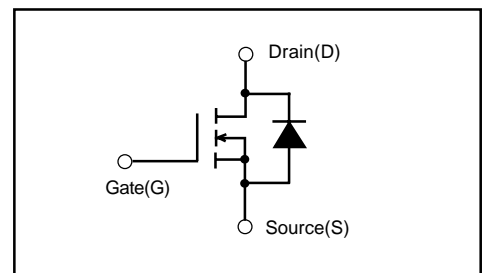

Characteristics

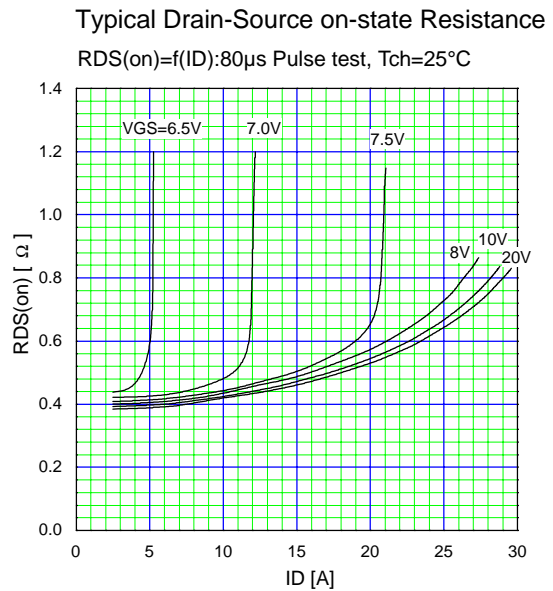
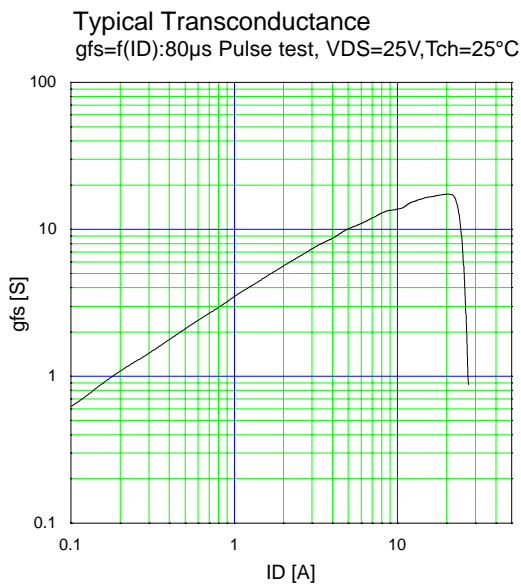
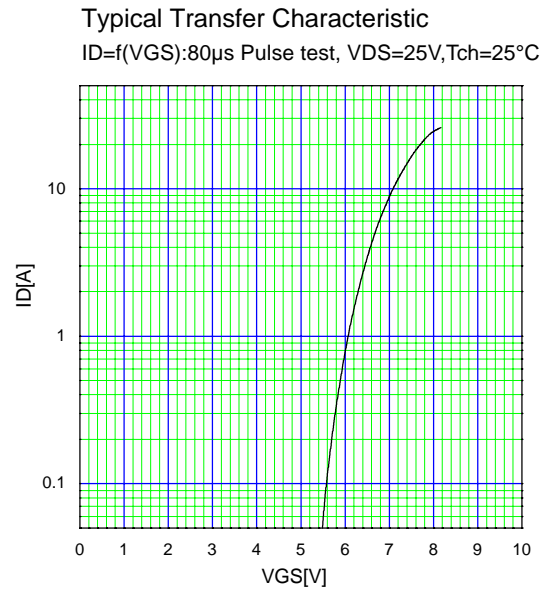
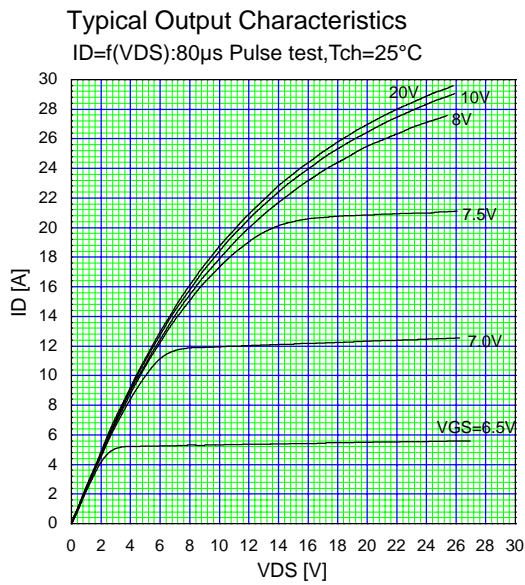
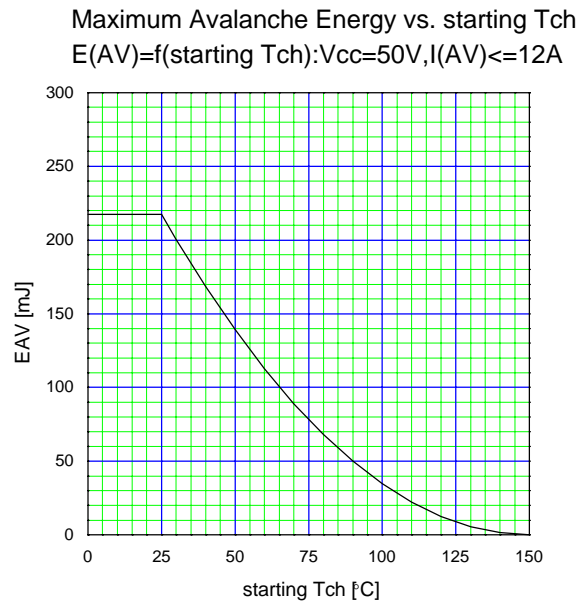
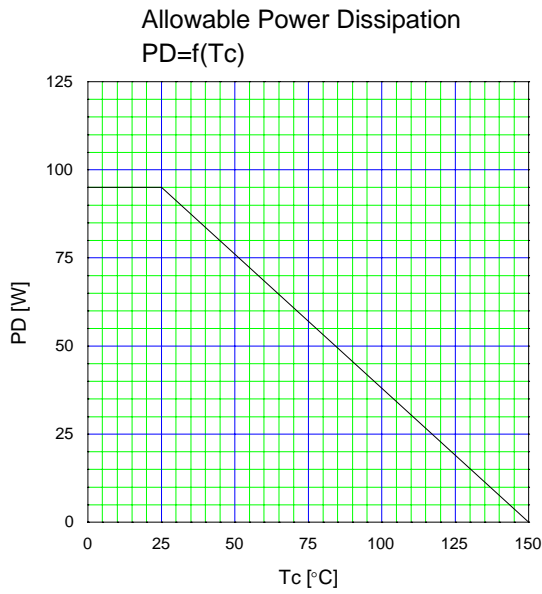

Drain-Source On-state Resistance  
 $R_{DS(on)}=f(T_{ch}):I_D=6A, V_{GS}=10V$

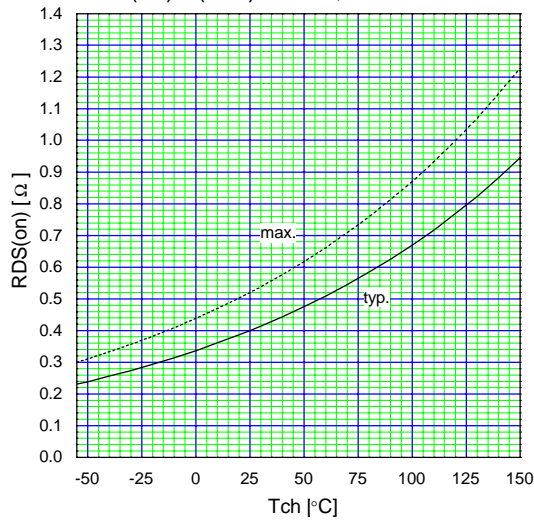

Gate Threshold Voltage vs. Tch  
 $V_{GS(th)}=f(T_{ch}):V_{DS}=V_{GS}, I_D=250\mu A$

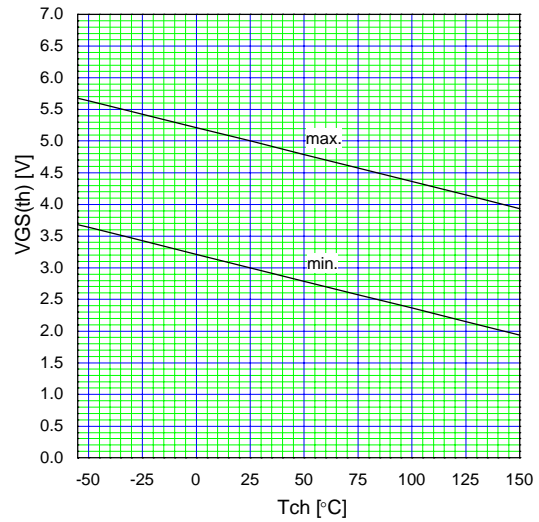

Typical Gate Charge Characteristics  
 $V_{GS}=f(Q_g):I_D=12A, T_{ch}=25^\circ C$

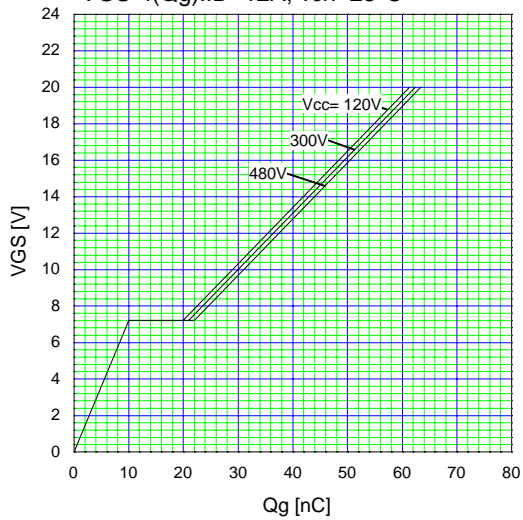

Typical Capacitance  
 $C=f(V_{DS}):V_{GS}=0V, f=1MHz$

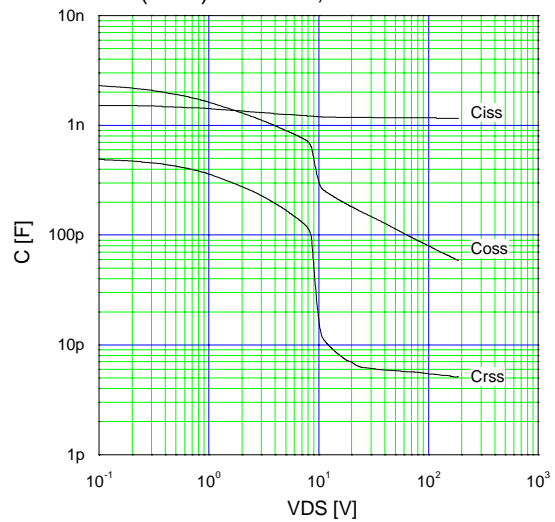

Typical Forward Characteristics of Reverse Diode  
 $I_F=f(V_{SD}):80\mu s \text{ Pulse test}, T_{ch}=25^\circ C$

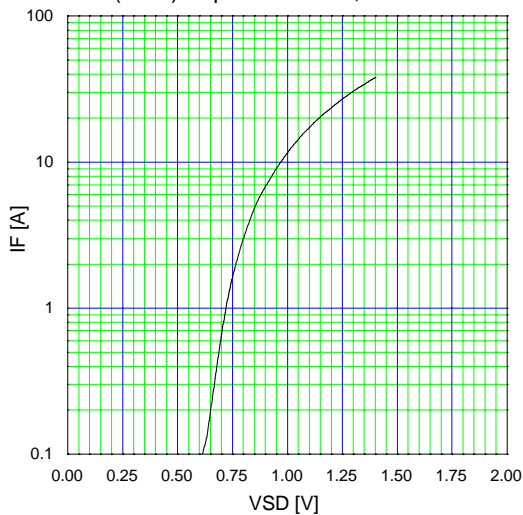

Typical Switching Characteristics vs. ID  
 $t=f(I_D):V_{cc}=300V, V_{GS}=10V, R_G=10\Omega$

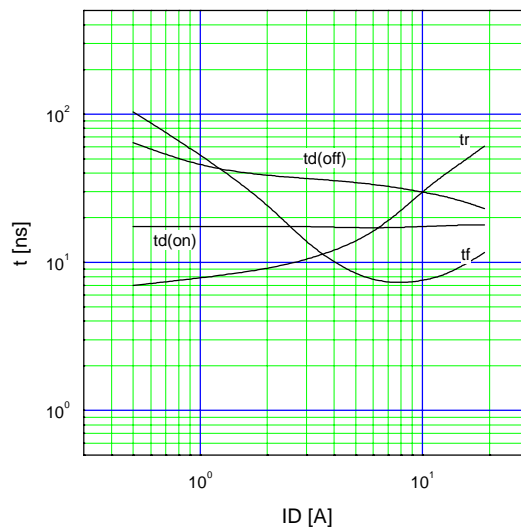

Transient Thermal Impedance  
 $Z_{th(ch-c)}=f(t):D=t/T$

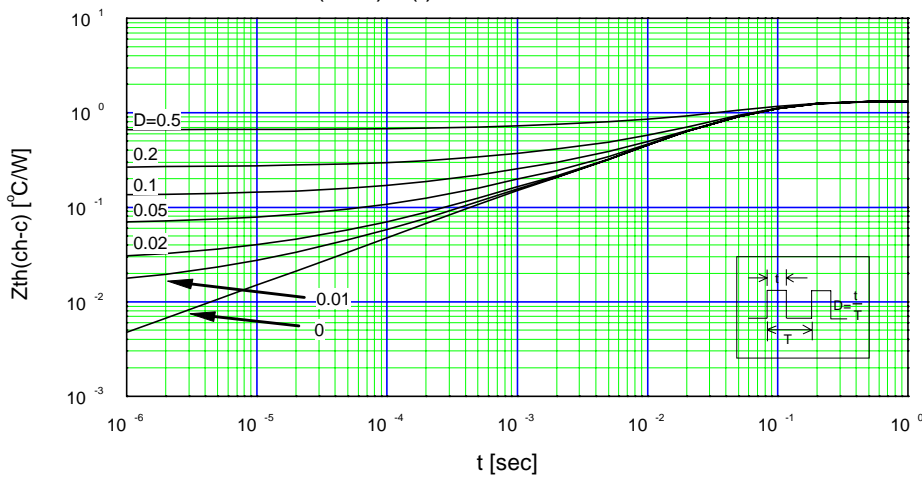

Maximum Avalanche Current Pulsewidth

$I_{AV}=f(t_{AV}):$  starting  $T_{ch}=25^{\circ}C$ .  $V_{CC}=50V$

