

Fuji power MOSFET Specification

2SK1016

1. Scope  
This specifies Fuji power MOSFET 2SK1016

2. Outline  
I) Construction N-channel enhancement mode power MOSFET  
II) Application for switching  
III) Outview TO-3P

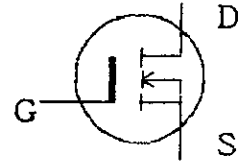

3. Absolute maximum ratings at  $T_c=25^\circ\text{C}$  (unless otherwise specified)

Description	Symbol	Characteristics	Unit	Remarks
Drain-source voltage	$V_{DS}$	500	V	
Drain-gate voltage	$V_{DGR}$	500	V	$R_{GS} = 20\text{K}\Omega$
Continuous Drain current	$I_D$	15	A	
Pulsed drain current	$I_{Dpulse}$	40	A	
Gate-source voltage	$V_{GS}$	$\pm 30$	V	
Maximum power dissipation	$P_D$	125	W	
Operating and storage temperature range	$T_j$	150	$^\circ\text{C}$	
	$T_{stg}$	-55 ~ +150	$^\circ\text{C}$	

4. Electrical characteristics at  $T_c=25^\circ\text{C}$  (unless otherwise specified)  
Static ratings

Description	Symbol	Conditions	Characteristics			Unit
			Min.	Typ.	Max.	
Drain-source breakdown voltage	$BV_{DSS}$	$I_D = 1\text{mA}$ $V_{GS} = 0\text{V}$	500			V
Gate threshold voltage	$V_{GS(th)}$	$I_D = 1\text{mA}$ $V_{DS} = V_{GS}$	2.5	3.5	5.0	V
Zero gate voltage drain current	$I_{DSS}$	$V_{DS} = 500\text{V}$ $V_{GS} = 0\text{V}$				$T_j = 25^\circ\text{C}$ $\mu\text{A}$
	$I_{DSS}$					$T_j = 125^\circ\text{C}$ mA
Gate-source leakage current	$I_{GSS}$	$V_{GS} = \pm 30\text{V}$ $V_{DS} = 0\text{V}$		10	100	nA
Drain-source on-state resistance	$R_{DS(on)}$	$I_D = 8\text{A}$ $V_{GS} = 10\text{V}$		0.36	0.55	$\Omega$

This material and the information herein is the property of Fuji Electric Co., Ltd. They shall be neither reproduced, copied, lent, or disclosed in any way whatsoever for the use of any third party nor used for the manufacturing purposes without the express written consent of Fuji Electric Co., Ltd.

REVISIONS			
-----------	--	--	--

DATE	NAME	APPROVED
Nov. 21 '89	N. Fujisawa	
Nov. 21 '89	S. Furukata	

Fuji Electric Co., Ltd.	
DWG. NO.	MT5F1306 1/5

Dynamic ratings

Description	Symbol	Conditions	Characteristics			Unit
			Min.	Typ.	Max.	
Forward transconductance	$g_{fs}$	$I_D = 8A$ $V_{DS} = 25V$	5.0	10.0		S
Input capacitance	$C_{iss}$	$V_{DS} = 25V$ $V_{GS} = 0V$ $f = 1MHz$		1800	2700	pF
Output capacitance	$C_{oss}$			270	410	pF
Reverse transfer capacitance	$C_{rss}$			120	185	pF
Turn-on time	$t_d(ON)$	$V_{CC} = 300V$ $V_{GS} = 10V$ $I_D = 15A$ $R_{GS} = 25\Omega$		70	110	ns
	$t_r$			100	150	ns
Turn-off time	$t_d(OFF)$			250	380	ns
	$t_f$			80	120	ns

Reverse diode

Description	Symbol	Conditions	Characteristics			Unit
			Min.	Typ.	Max.	
Continuous reverse drain current	$I_{DR}$				15	A
Pulsed reverse deain current	$I_{DRM}$				40	A
Diode forward on-voltage	$V_{SD}$	$I_F = 2 \times I_{DR}$ $V_{GS} = 0V, T_j = 25^\circ C$		1.1	1.65	V
Reverse recovery time	$t_{rr}$	$I_F = I_{DR}$ $V_{GS} = 0V$ $-dI_F/dt = 100A/\mu s$ $T_j = 25^\circ C$		400		ns
Reverse recovery charge	$Q_{rr}$				4	$\mu C$

5. Thermal resistance

Description	Symbol	Conditions	Characteristics			Unit
			Min.	Typ.	Max.	
Thermal resistance	$R_{th j-c}$				1.0	$^\circ C/W$
	$R_{th j-a}$				35.0	$^\circ C/W$

This material and the information herein is the property of Fuji Electric Co., Ltd. They shall be neither reproduced, copied, lent, or disclosed in any way whatsoever for the use of any third party nor used for the manufacturing purposes without the express written consent of Fuji Electric Co., Ltd.

DATE	NAME	APPROVED	Fuji Electric Co., Ltd.	
DRAWN				
CHECKED			DWG. NO.	MT5 F 1306
REVISIONS				2/5

6. 御注意 (Attention)

本製品は外国為替および外国貿易管理法の規定により戦略物資（または役務）に該当  
 しますので、輸出する場合には、同法に基づく通商産業大臣の輸出許可が必要です。

This product described in this specification contain strategic product subject  
 to COCOM requirements. They should not be exported without authorization from the  
 appropriate governmental authorities.

This material and the information herein is the property of  
 Fuji Electric Co., Ltd. They shall be neither reproduced, copied,  
 lent, or disclosed in any way whatsoever for the use of any  
 third party nor used for the manufacturing purposes without  
 the express written consent of Fuji Electric Co., Ltd.

REVISIONS			
-----------	--	--	--

	DATE	NAME	APPROVED	Fuji Electric Co., Ltd.	
DRAWN	- -			DWG. NO.	MT5 F1306
CHECKED	- -				

MA4LE

Power dissipation

$$P_D = f(T_C)$$

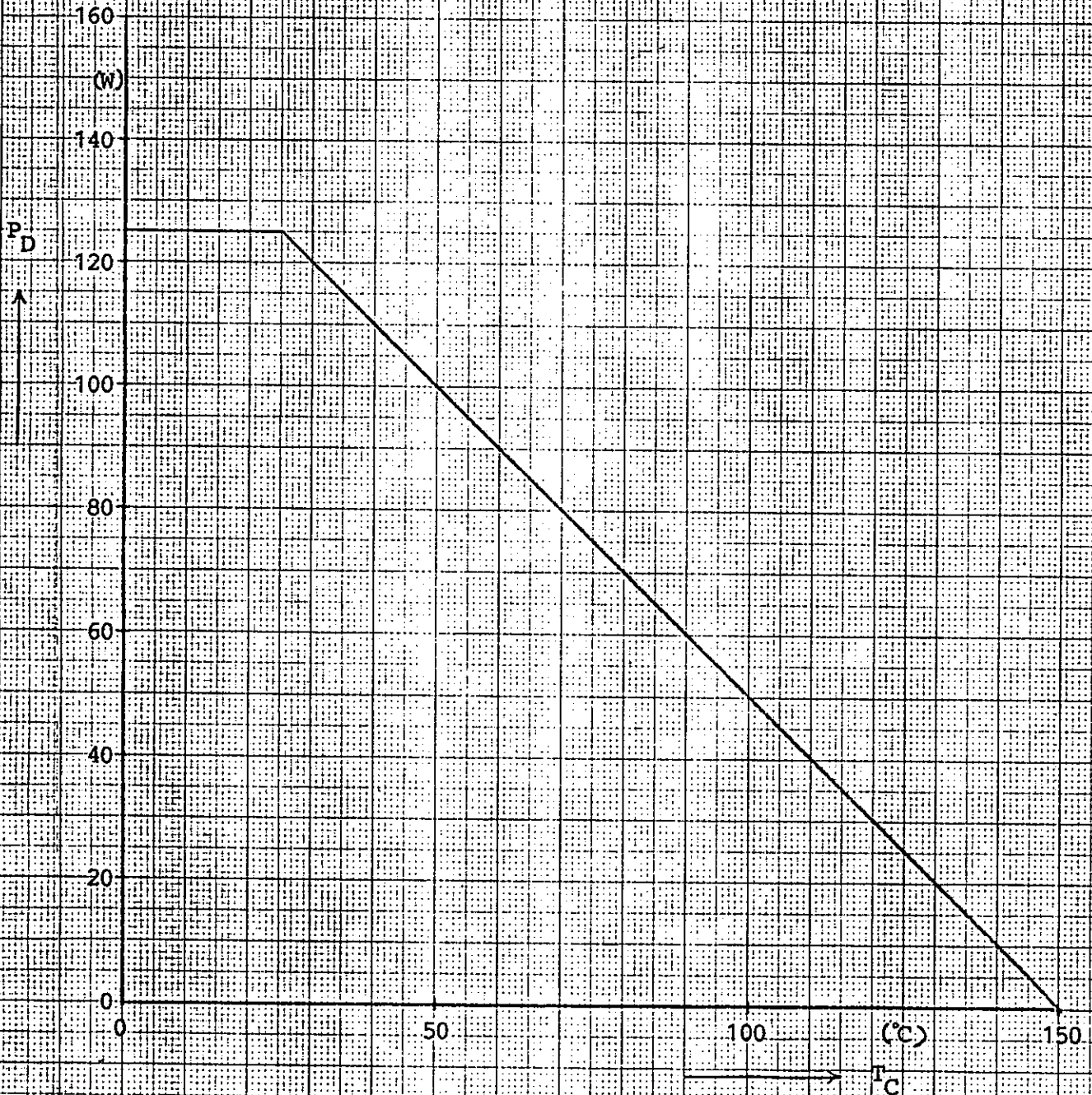

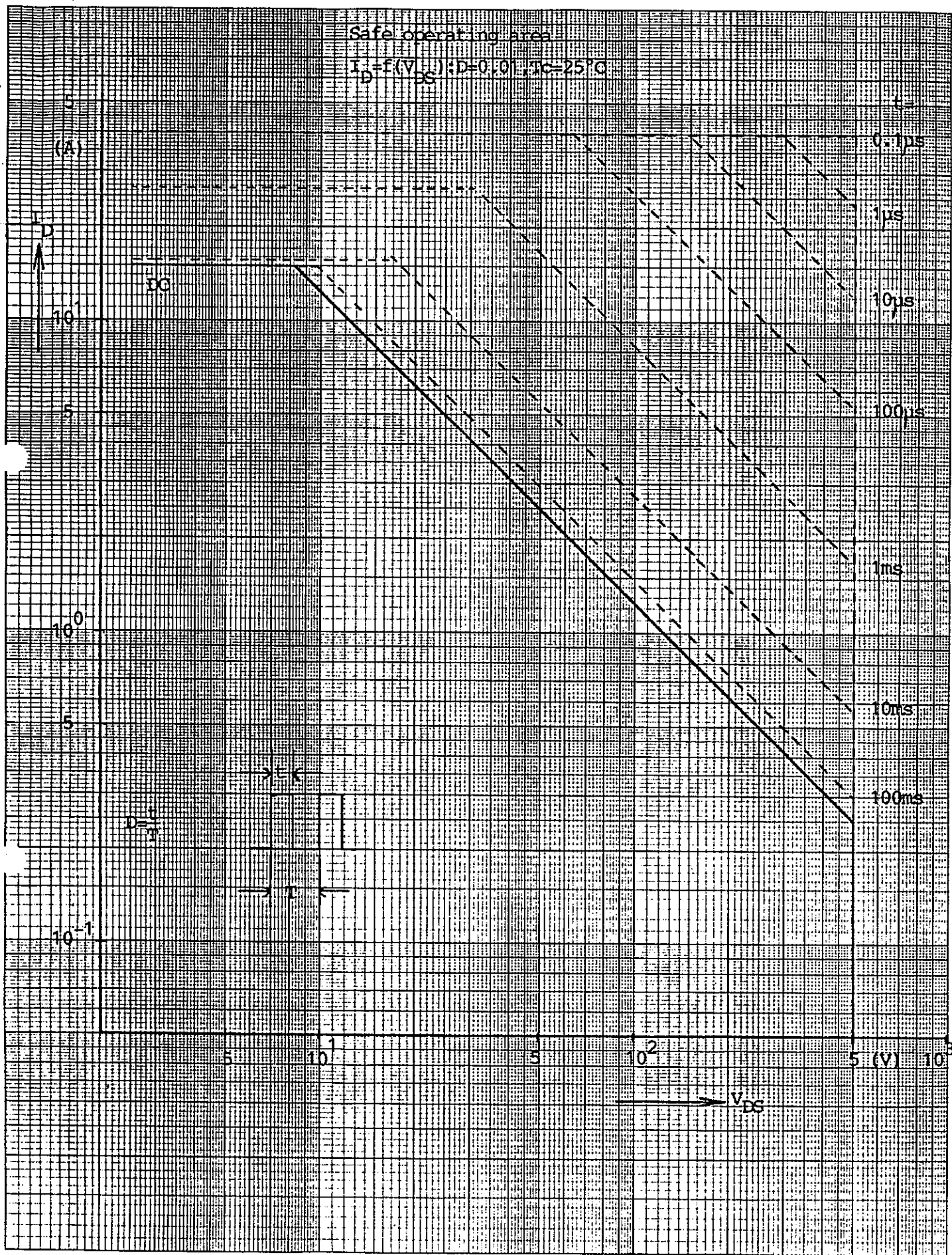

**MT5F1306**  $\frac{5}{5}$

Typical output characteristics

$I_D = f(V_{DS})$ : 80 $\mu$ s pulse test,  $T_j = 25^\circ\text{C}$

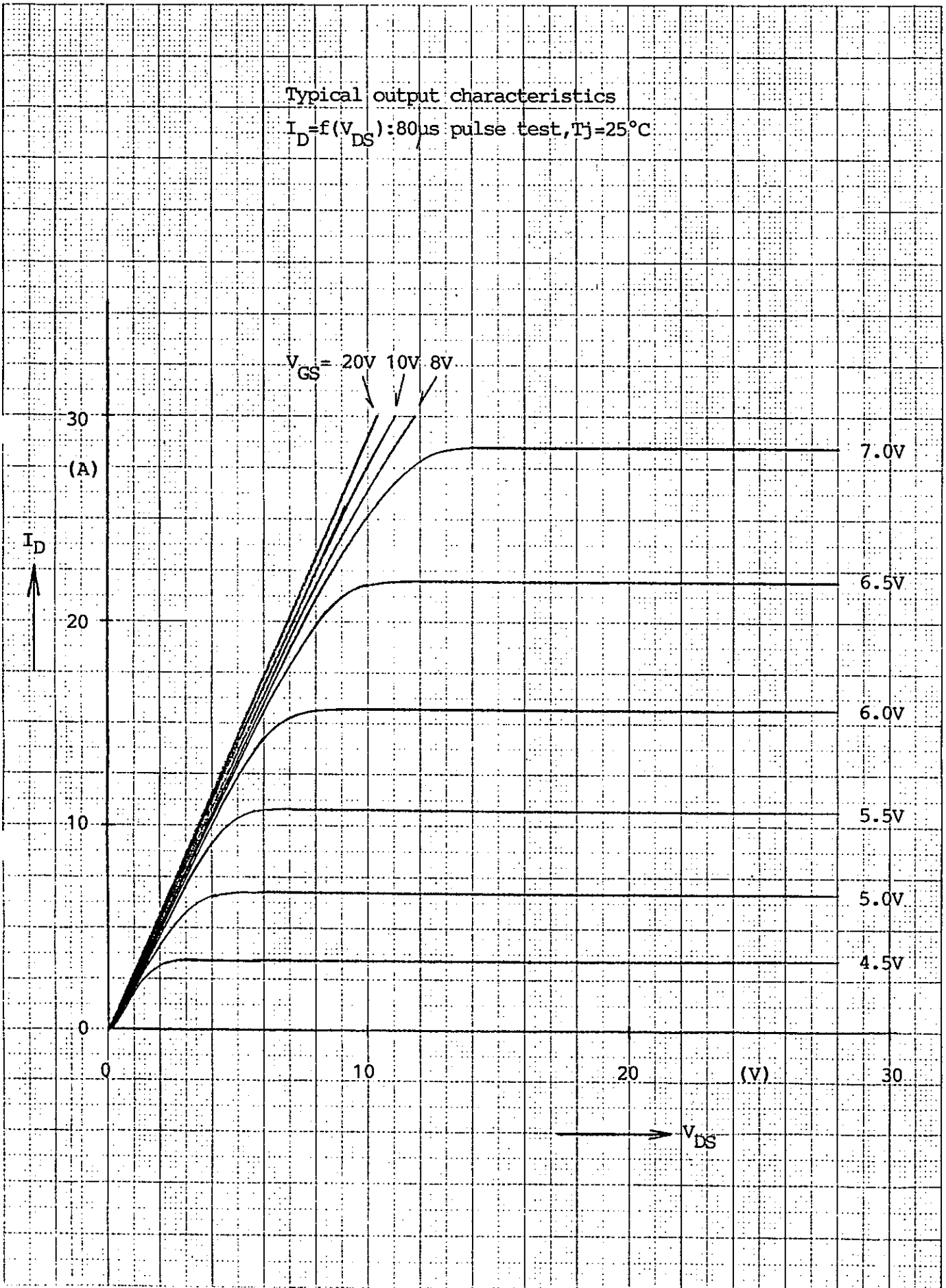

Typical transfre characteristics

$I_D = f(V_{GS})$ : 80 $\mu$ s pulse test,  $V_{DS} = 25V, T_j = 25^\circ C$

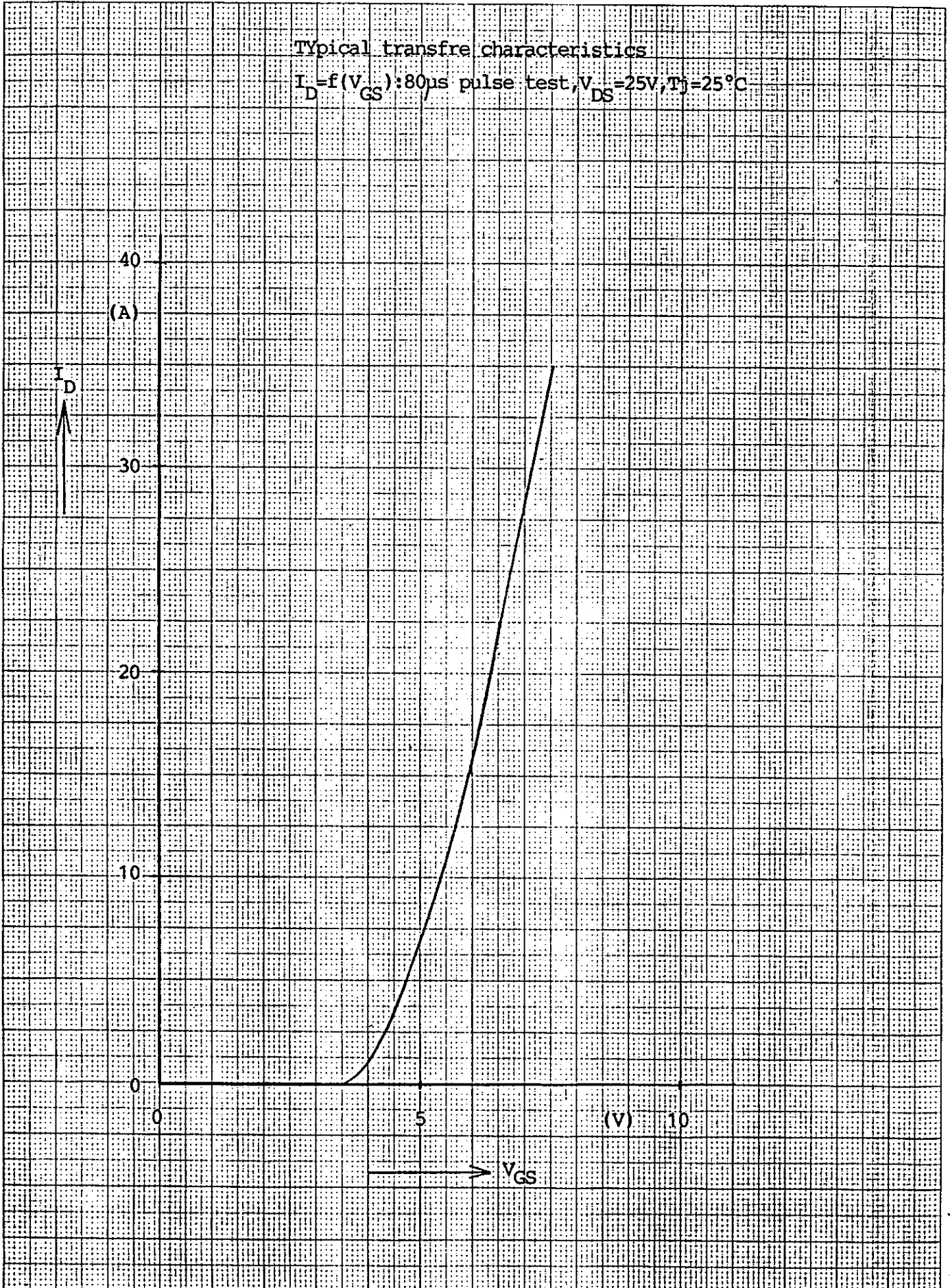

Typical transconductance

$g_{fs} = f(I_D)$ : 80 $\mu$ s pulse test,  $V_{DS} = 25V$ ,  $T_J = 25^\circ C$

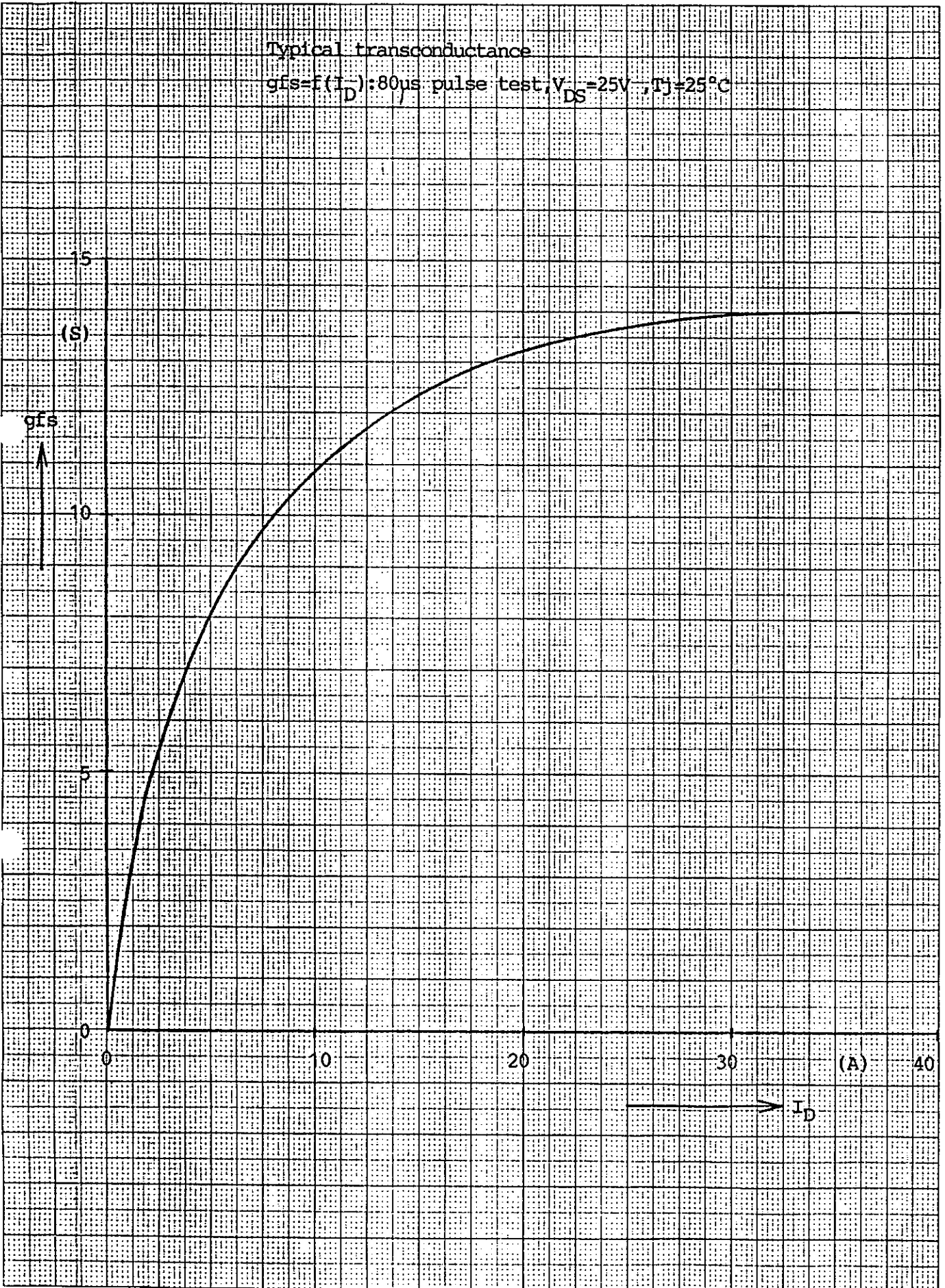

MT5F1306 8/5



Typical drain-source on-state resistance

$$R_{DS(on)} = f(I_D, V_{GS}, T_j = 25^\circ\text{C})$$

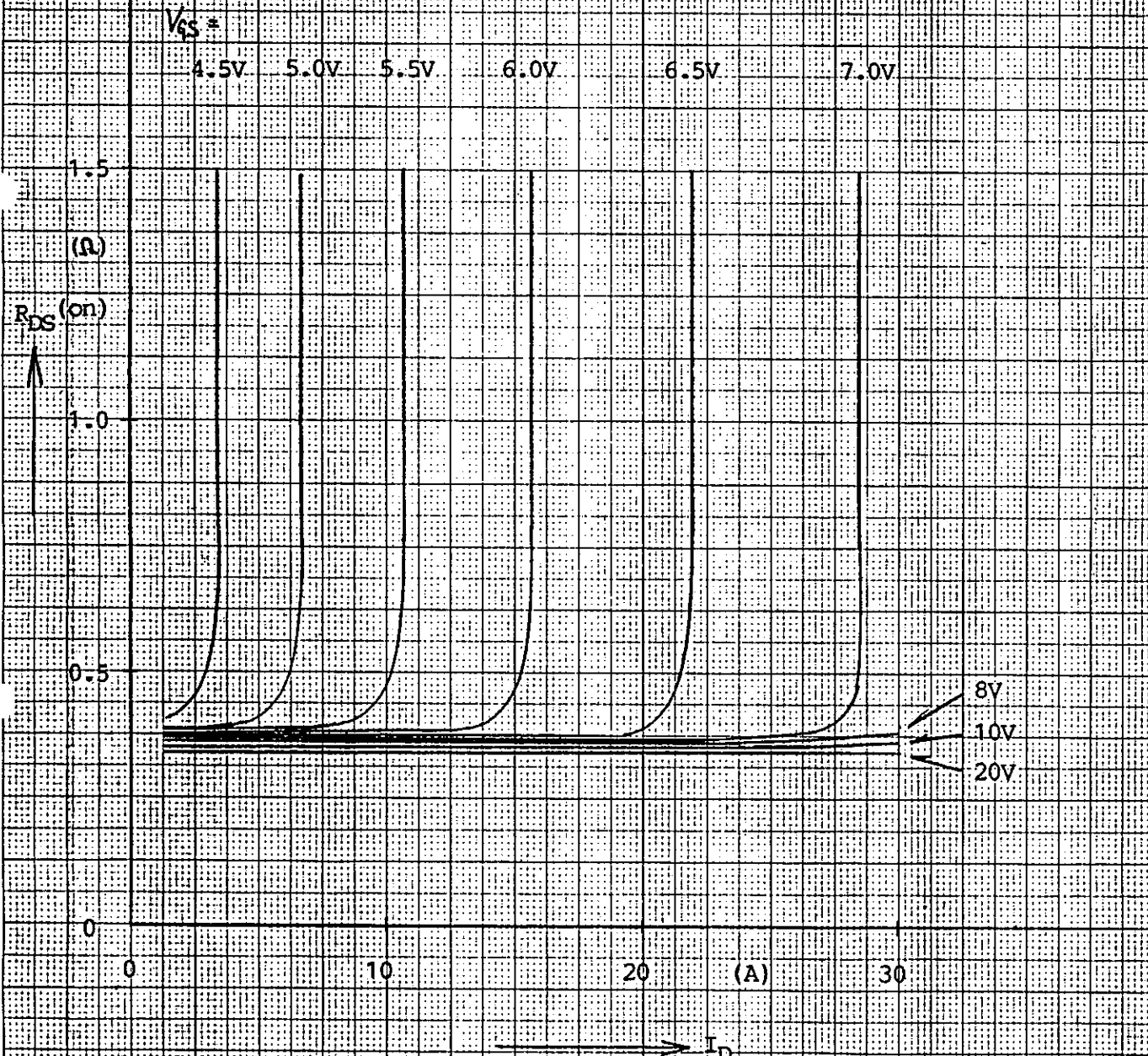

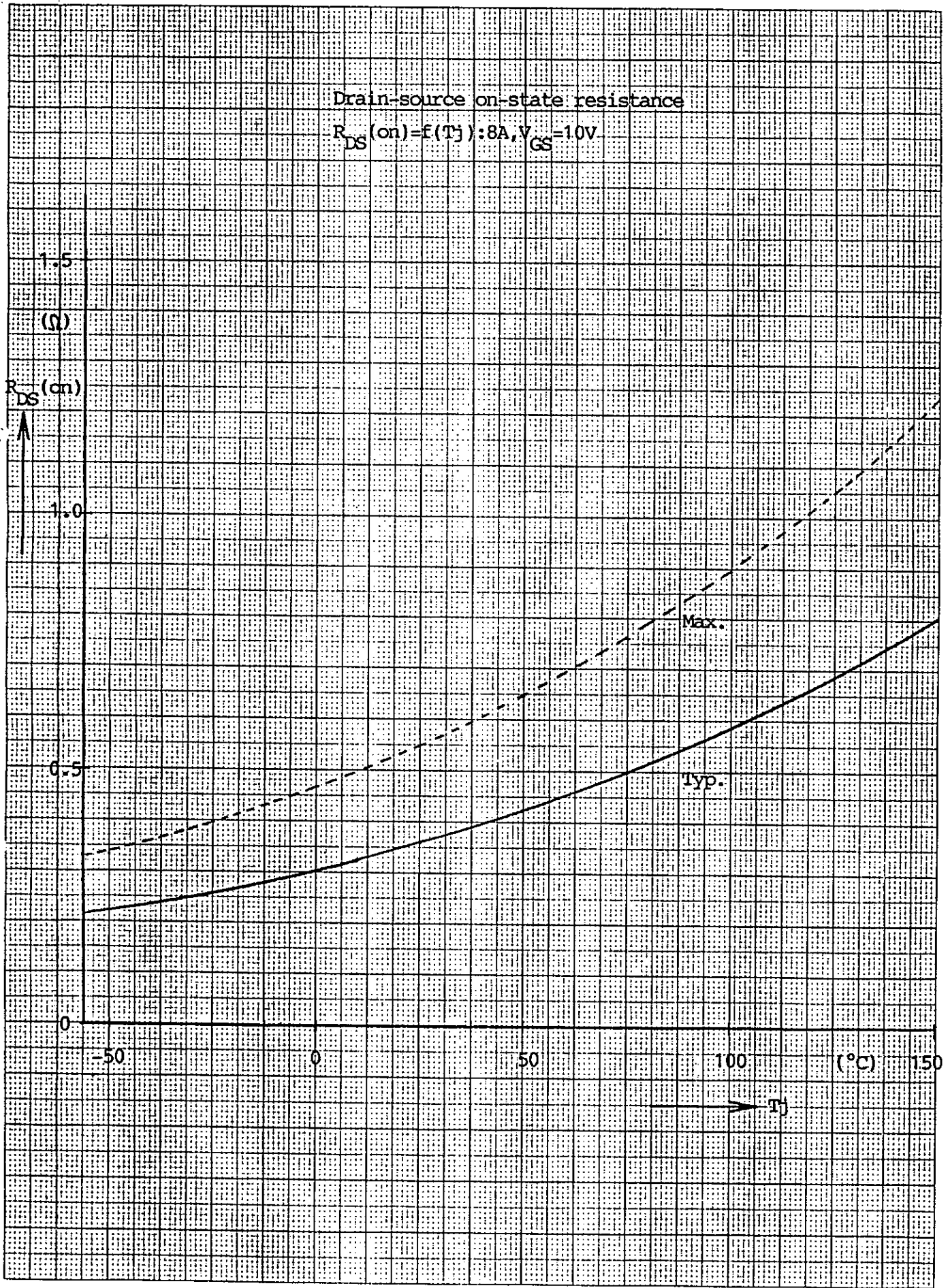

Gate threshold voltage

$$V_{GS(th)} = f(T_j): I_D = 1\text{mA}, V_{DS} = V_{GS}$$

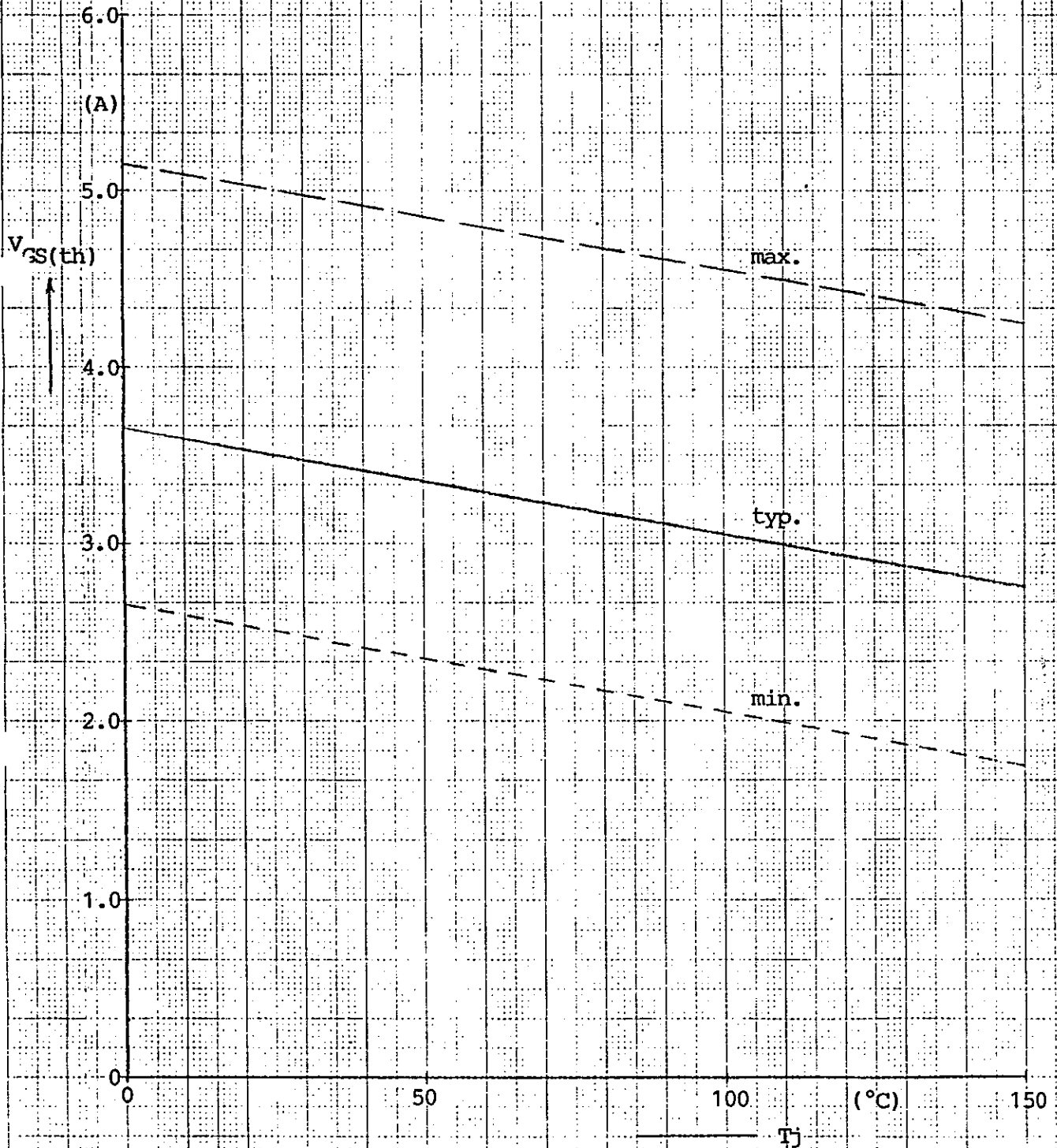

Typical gate charge characteristics

$V_{GS} = f(Q_g); I_D = 15A$

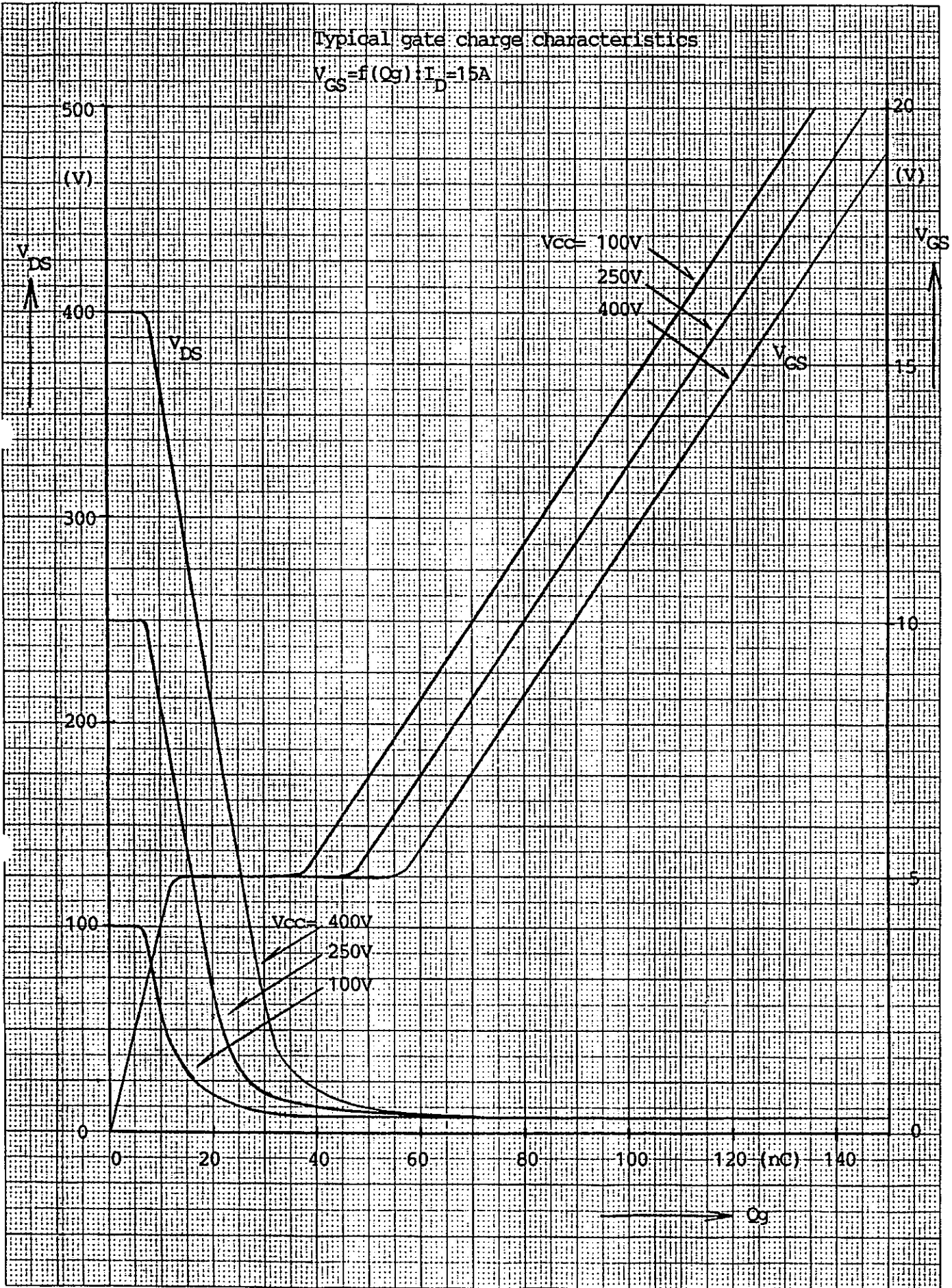

Typical capacitances  
 $C=f(V_{DS}): V_{GS}=0V, f=1MHz$

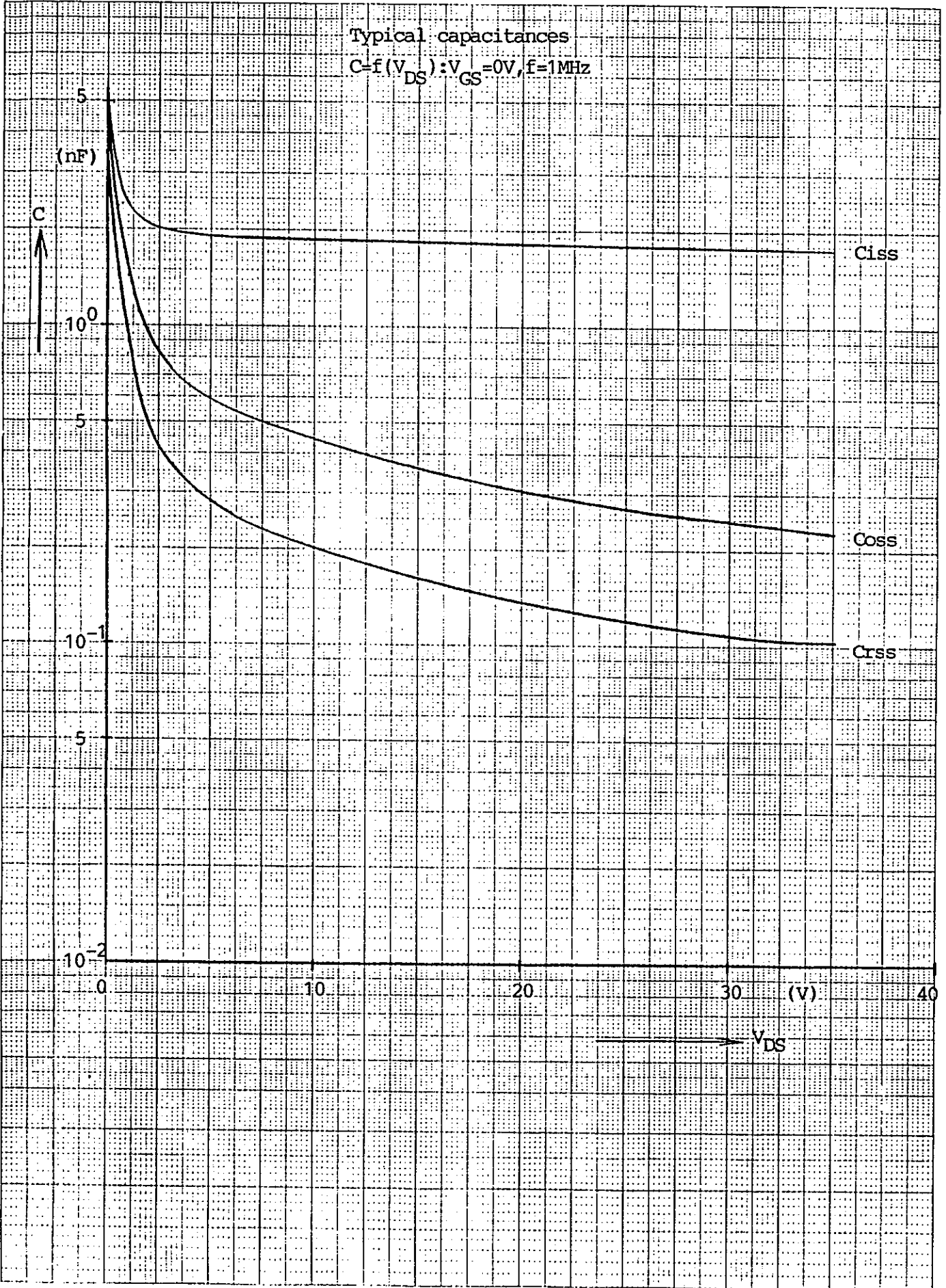

Forward characteristic of reverse diode

$I_F = f(V_{SD})$ : 80 $\mu$ s pulse test

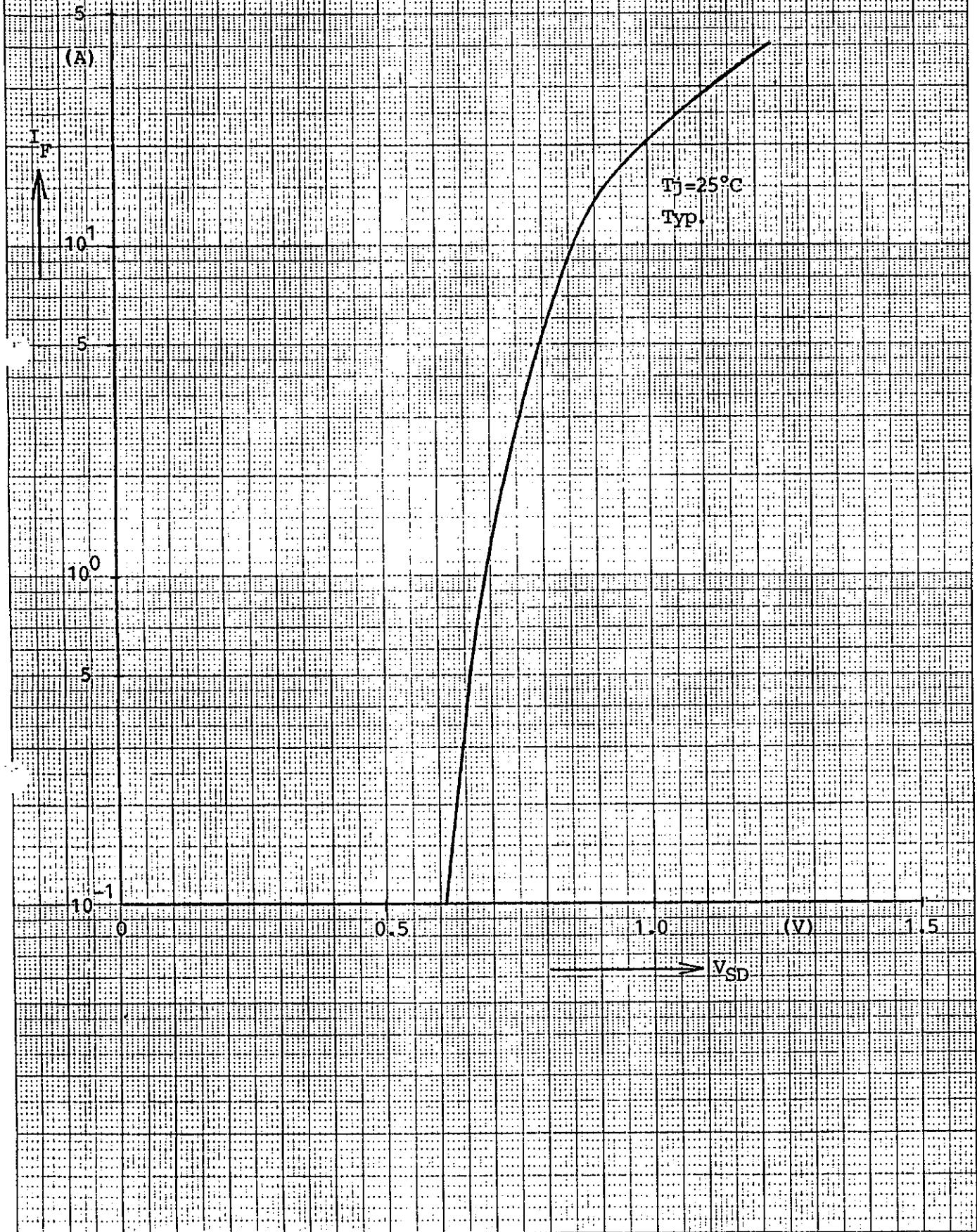

Transient thermal impedance  $Z_{thjc} = f(t)$   
 parameter:  $D = t/T$

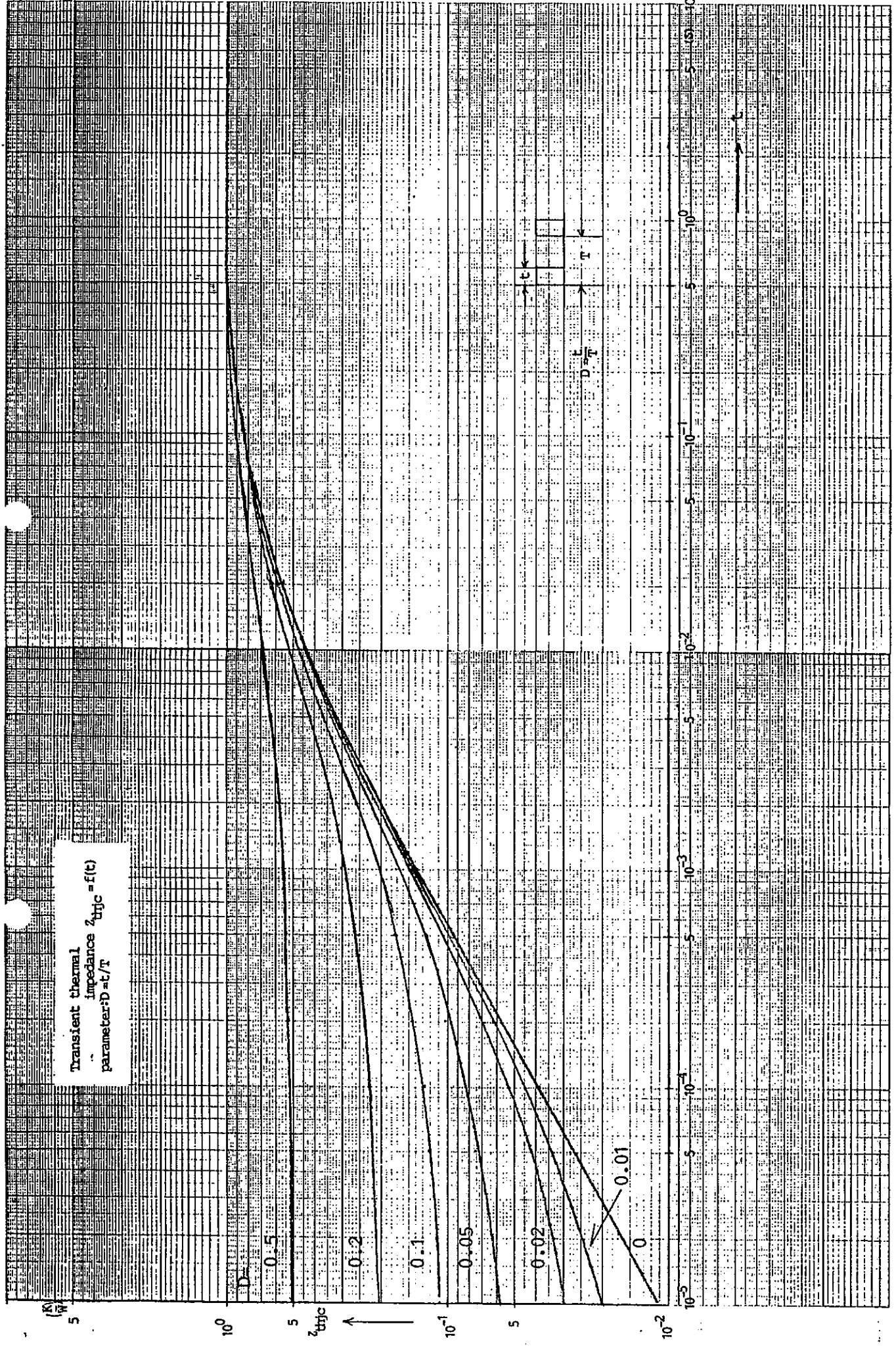

MT5 F1306

15/15

FUJI POWER MOS FET

TYPE : 2SKI016

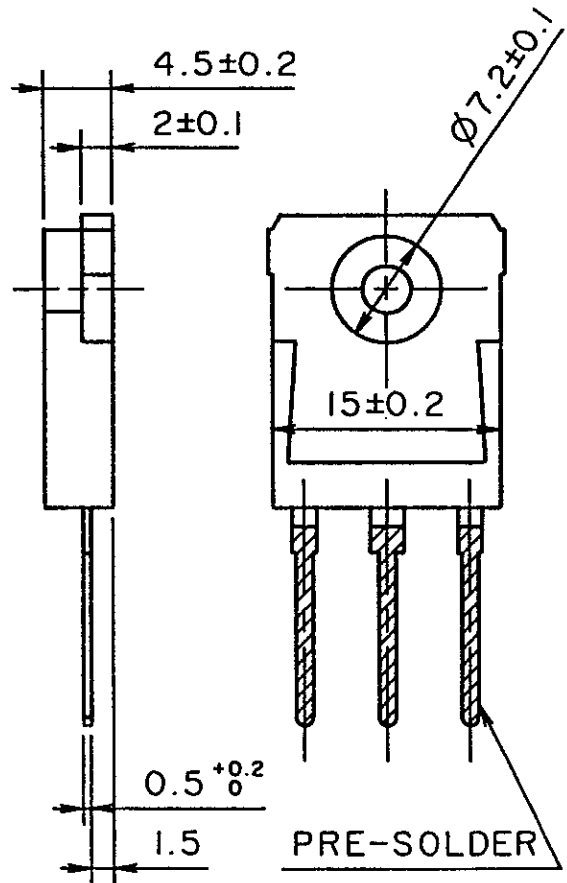
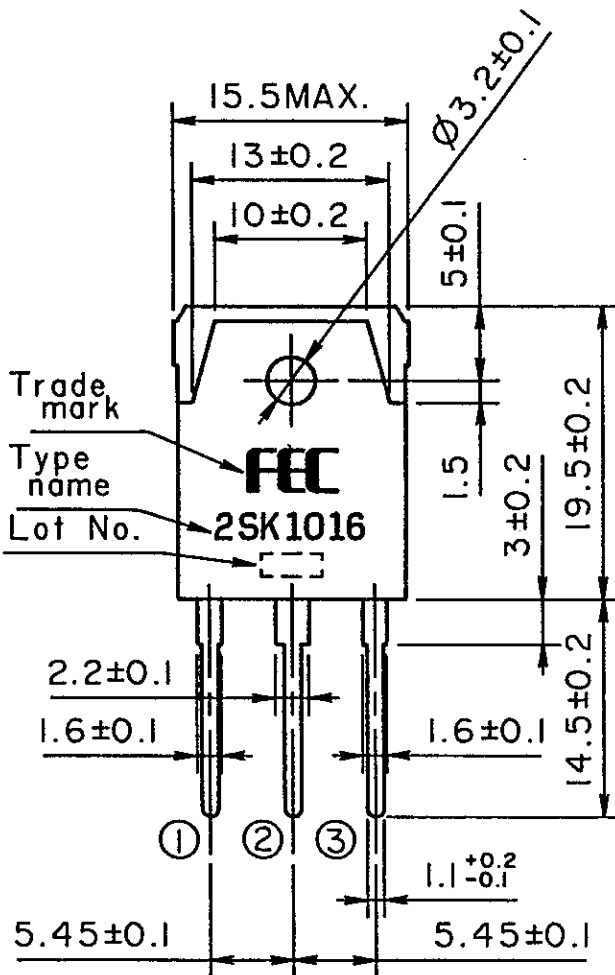

DIMENSIONS ARE IN MILLIMETERS.

CONNECTION

- ① GATE
- ② DRAIN
- ③ SOURCE

JEDEC : TO-228AA  
EIAJ : SC-65

MS.T03P.2SKI016

This material and the information herein is the property of Fuji Electric Co., Ltd. They shall be neither reproduced, copied, lent, or disclosed in any way whatsoever for the use of any third party nor used for the manufacturing purposes without the express written consent of Fuji Electric Co., Ltd.

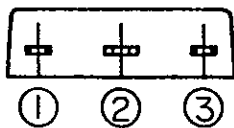

	DATE	NAME	APPROVED
DRAWN	'89-11-24	H. TAKEDA	M. Miyagi
CHECKED	'89-11-24	A. MARUYAMA	

Fuji Electric Co., Ltd.	
DWG. NO.	MK5C24516

REVISIONS