

LAPT 2SA1386/1386A

Silicon PNP Epitaxial Planar Transistor (Complement to type 2SC3519/A)

Application : Audio and General Purpose

■ Absolute maximum ratings (Ta=25°C)

Symbol	Ratings		Unit
	2SA1386	2SA1386A	
V _{CBO}	-160	-180	V
V _{CEO}	-160	-180	V
V _{EBO}	-5		V
I _C	-15		A
I _B	-4		A
P _C	130(T _C =25°C)		W
T _j	150		°C
T _{stg}	-55 to +150		°C

■ Electrical Characteristics (Ta=25°C)

Symbol	Conditions	Ratings		Unit
		2SA1386	2SA1386A	
I _{CBO}	V _{CB} =	-100max	-100max	μA
I _{EBO}	V _{EB} =-5V	-160	-180	μA
V _{(BR)CEO}	I _C =-25mA	-160min	-180min	V
h _{FE}	V _{CE} =-4V, I _C =-5A	50min*		
V _{CE(sat)}	I _C =-5A, I _B =-0.5A	-2.0max		V
f _T	V _{CE} =-12V, I _E =2A	40typ		MHz
COB	V _{CB} =-10V, f=1MHz	500typ		pF

*h_{FE} Rank O(50to100), P(70to140), Y(90to180)

■ Typical Switching Characteristics (Common Emitter)

V _{CC} (V)	R _L (Ω)	I _C (A)	V _{BB1} (V)	V _{BB2} (V)	I _{B1} (A)	I _{B2} (A)	t _{on} (μs)	t _{stg} (μs)	t _f (μs)
-40	4	-10	-10	5	-1	1	0.3typ	0.7typ	0.2typ

External Dimensions MT-100(TO3P)

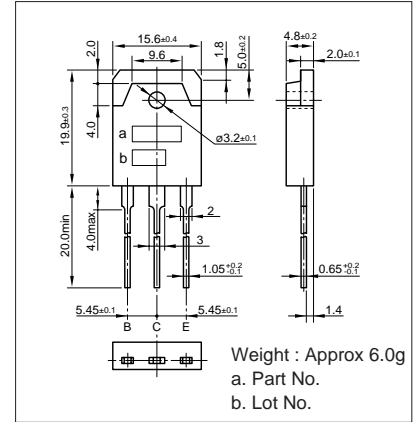

Weight : Approx 6.0g
a. Part No.
b. Lot No.

I_C-V_{CE} Characteristics (Typical)

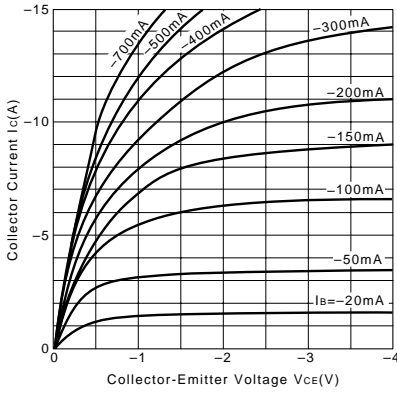

V_{CE(sat)}-I_B Characteristics (Typical)

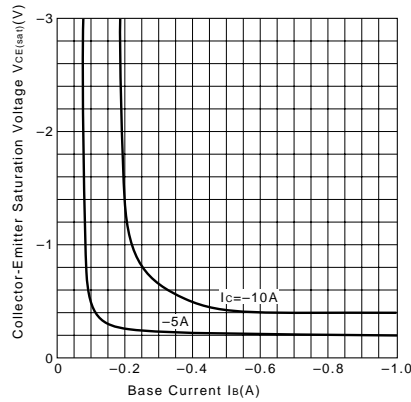

I_C-V_{BE} Temperature Characteristics (Typical)

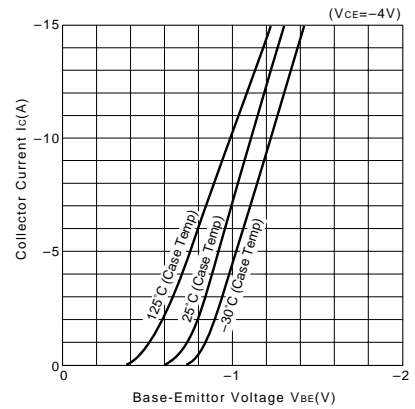

h_{FE}-I_C Characteristics (Typical)

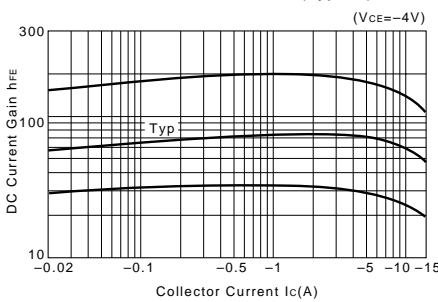

h_{FE}-I_C Temperature Characteristics (Typical)

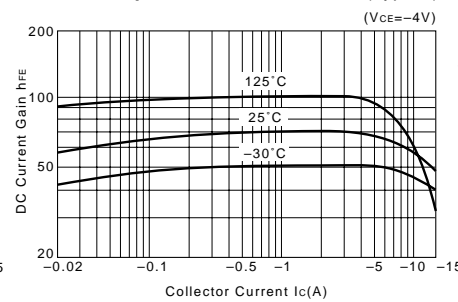

θ_{j-a}-t Characteristics

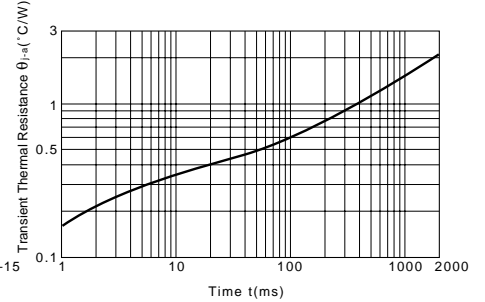

f_T-I_E Characteristics (Typical)

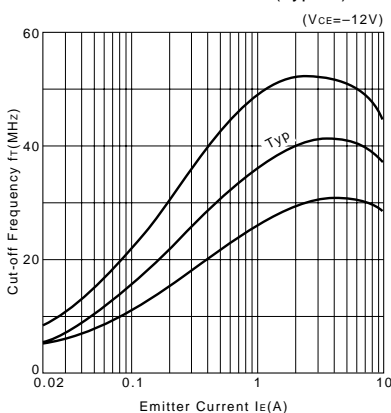

Safe Operating Area (Single Pulse)

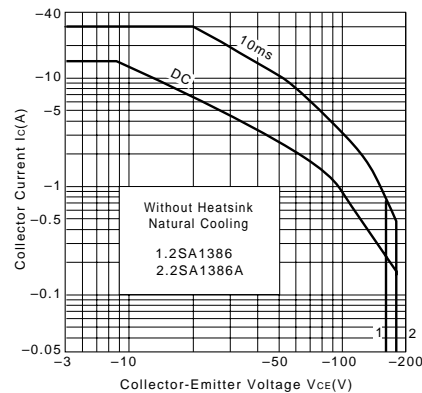

P_C-T_a Derating

