

2N6504 Series

SCRs-25 AMPERES RMS- 50 - 800V

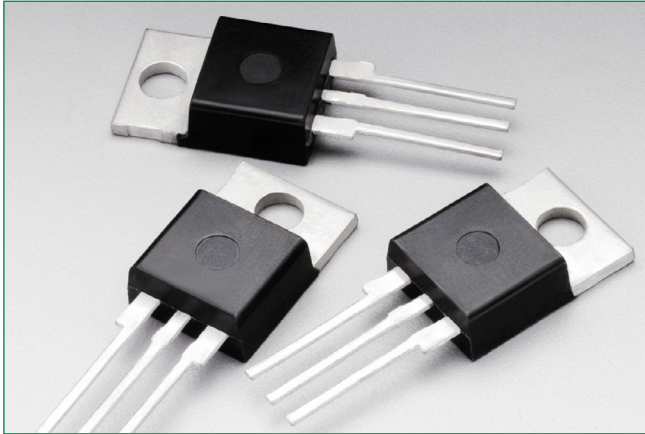

Description

The 2N6504 is designed primarily for half-wave AC control applications, such as motor controls, heating controls and power supply crowbar circuits.

Features

- Glass Passivated Junctions for Greater Parameter Uniformity and Stability
- Small, Rugged, Thermowatt Construction for Low Thermal Resistance, High Heat Dissipation and Durability
- Blocking Voltage to 800 Volts
- 300 A Surge Current Capability
- Pb-Free Package is Available

Additional Information



Resources



Accessories



Samples

Functional Diagram



Pin Out

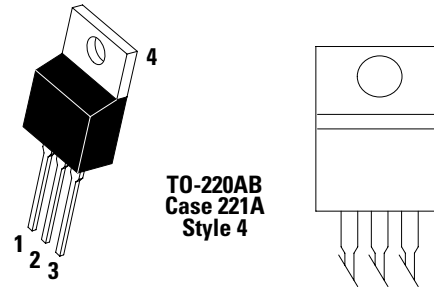

2N6504 Series

SCRs-25 AMPERES RMS– 50 - 800V

Maximum Ratings ($T_J = 25^\circ\text{C}$ unless otherwise noted)

Rating	Symbol	Value	Unit
Peak Repetitive Off-State Voltage (Note 1) (Gate Open, Sine Wave 50 to 60 Hz, $T_J = 25$ to 125°C)	2N6504	50	V
	2N6505	100	
	2N6507	400	
	2N6508	600	
	2N6509	800	
On-State RMS Current (180° Conduction Angles; $T_C = 85^\circ\text{C}$)	$I_{T(RMS)}$	25	A
Average On-State Current (180° Conduction Angles; $T_C = 85^\circ\text{C}$)	$I_{T(AV)}$	16	A
Peak Non-repetitive Surge Current (1/2 Cycle, Sine Wave 60 Hz, $T_J = 100^\circ\text{C}$)	I_{TSM}	250	A
Forward Peak Gate Power (Pulse Width $\leq 1.0 \mu\text{s}$, $T_C = 85^\circ\text{C}$)	P_{GM}	20	W
Forward Average Gate Power ($t = 8.3 \text{ ms}$, $T_C = 85^\circ\text{C}$)	$P_{G(AV)}$	0.5	W
Forward Peak Gate Current (Pulse Width $\leq 1.0 \mu\text{s}$, $T_C = 85^\circ\text{C}$)	I_{GM}	2.0	A
Operating Junction Temperature Range	T_J	-40 to +125	$^\circ\text{C}$
Storage Temperature Range	T_{stg}	-40 to +150	$^\circ\text{C}$

Stresses exceeding Maximum Ratings may damage the device. Maximum Ratings are stress ratings only. Functional operation above the Recommended Operating Conditions is not implied. Extended exposure to stresses above the Recommended Operating Conditions may affect device reliability.

1. V_{DRM} and V_{RRM} for all types can be applied on a continuous basis. Ratings apply for zero or negative gate voltage; however, positive gate voltage shall not be applied concurrent with negative potential on the anode. Blocking voltages shall not be tested with a constant current source such that the voltage ratings of the devices are exceeded.

Thermal Characteristics

Rating	Symbol	Value	Unit
*Thermal Resistance, Junction to Case	$R_{\theta JC}$	1.5	$^\circ\text{C}/\text{W}$
*Maximum Lead Temperature for Soldering Purposes, 1/8" from case for 10 seconds	T_L	260	$^\circ\text{C}$

* Indicates JEDEC Registered Data.

Electrical Characteristics - OFF ($T_C = 25^\circ\text{C}$ unless otherwise noted)

Characteristic	Symbol	Min	Typ	Max	Unit
†Peak Repetitive Blocking Current ($V_{AK} = V_{DRM} = V_{RRM}$; Gate Open)	I_{DRM} I_{RRM}	-	-	10	μA
				2.0	mA

Electrical Characteristics - ON ($T_C = 25^\circ\text{C}$ unless otherwise noted; Electricals apply in both directions)

Characteristic	Symbol	Min	Typ	Max	Unit
* Forward On-State Voltage (Note 2) (ITM = 50 A)	V_{TM}	-	-	1.8	V
* Gate Trigger Current (Continuous dc) ($V_{AK} = 12 \text{ V}_{dc}$, $R_L = 100 \Omega$)	I_{GT}	-	9.0	30	mA
			-	75	
* Gate Trigger Voltage (Continuous dc) ($V_{AK} = 12 \text{ V}_{dc}$, $R_L = 100 \Omega$, $T_C = -40^\circ\text{C}$)	V_{GT}	-	1.0	1.5	V
Gate Non-Trigger Voltage ($V_{AK} = 12 \text{ V}_{dc}$, $R_L = 100 \Omega$, $T_J = 125^\circ\text{C}$)	V_{GD}	0.2	-	-	V
* Holding Current ($V_D = 12 \text{ V}_{dc}$, Initiating Current = 200 mA, Gate Open)	I_H	-	18	40	mA
			-	80	
* Turn-On Time ($I_{TM} = 25 \text{ A}$, $I_{GT} = 50 \text{ mAdc}$)	t_{gt}	-	1.5	2.0	μs
Turn-Off Time ($V_{DRM} = \text{rated voltage}$)	t_q	-	15	-	μs
			35	-	μs

* Indicates JEDEC Registered Data

2. Pulse Test: Pulse Width $\leq 300 \mu\text{sec}$, Duty Cycle $\leq 2\%$.

2N6504 Series

SCRs-25 AMPERES RMS- 50 - 800V

Dynamic Characteristics

Characteristic	Symbol	Min	Typ	Max	Unit
Critical Rate of Rise of Off-State Voltage (Gate Open, Rated V_{DRM} , Exponential Waveform)	dv/dt	-	50	-	V/ μ s

Voltage Current Characteristic of SCR

Symbol	Parameter
V_{DRM}	Peak Repetitive Forward Off State Voltage
I_{DRM}	Peak Forward Blocking Current
V_{RRM}	Peak Repetitive Reverse Off State Voltage
I_{RRM}	Peak Reverse Blocking Current
V_{TM}	Maximum On State Voltage
I_H	Holding Current

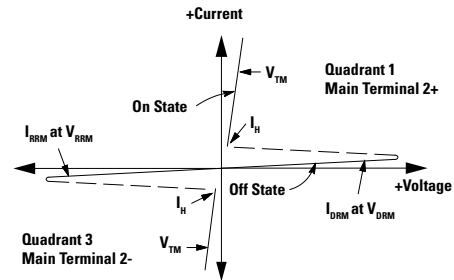

Figure 1. Average Current Derating

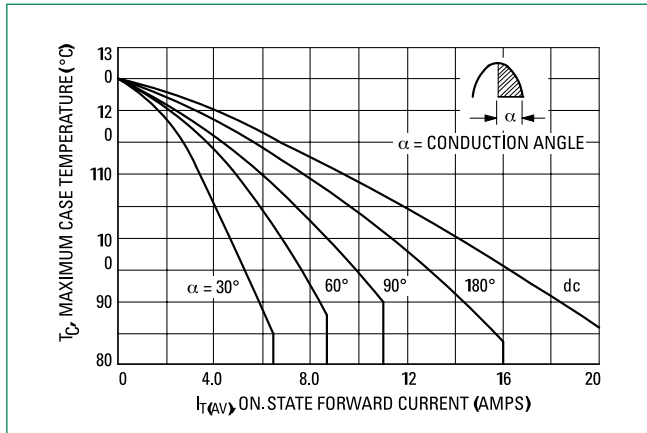
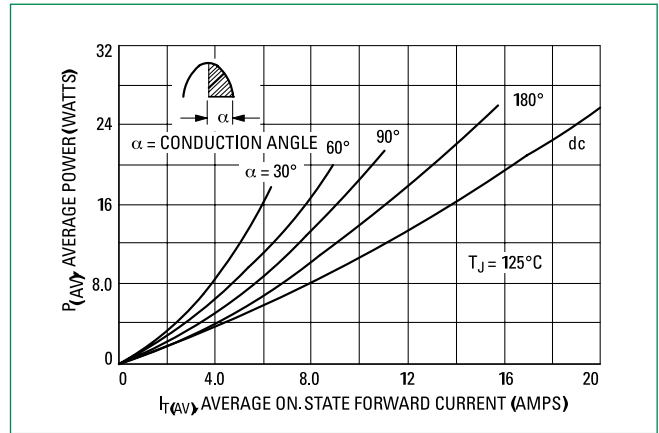

Figure 2. Maximum On-State Power Dissipation



2N6504 Series

SCRs-25 AMPERES RMS- 50 - 800V

Figure 3. Typical On-State Characteristics

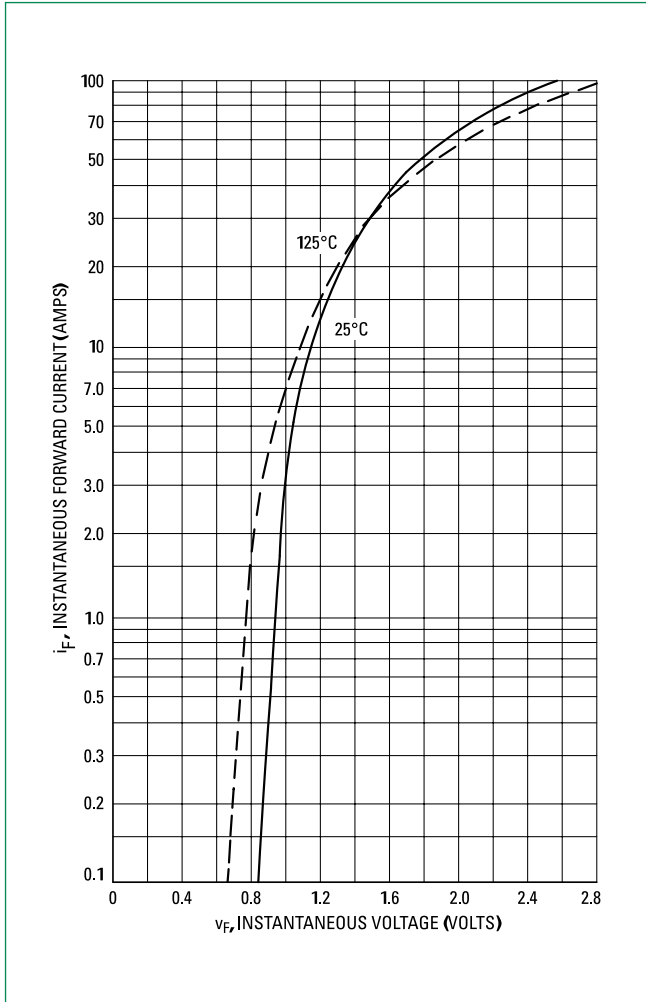

Figure 4. Maximum Non-Repetitive Surge Current

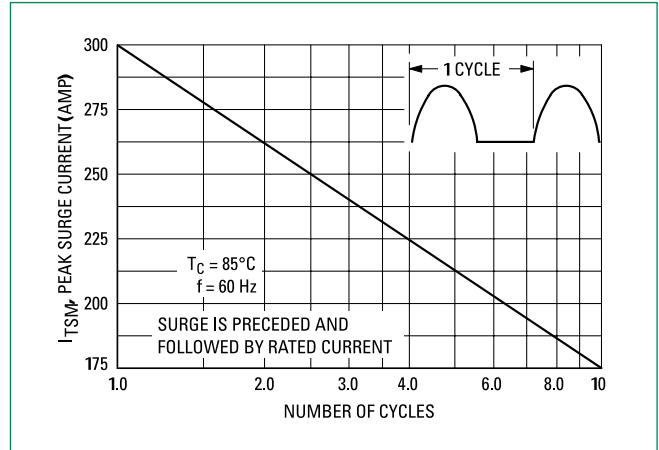
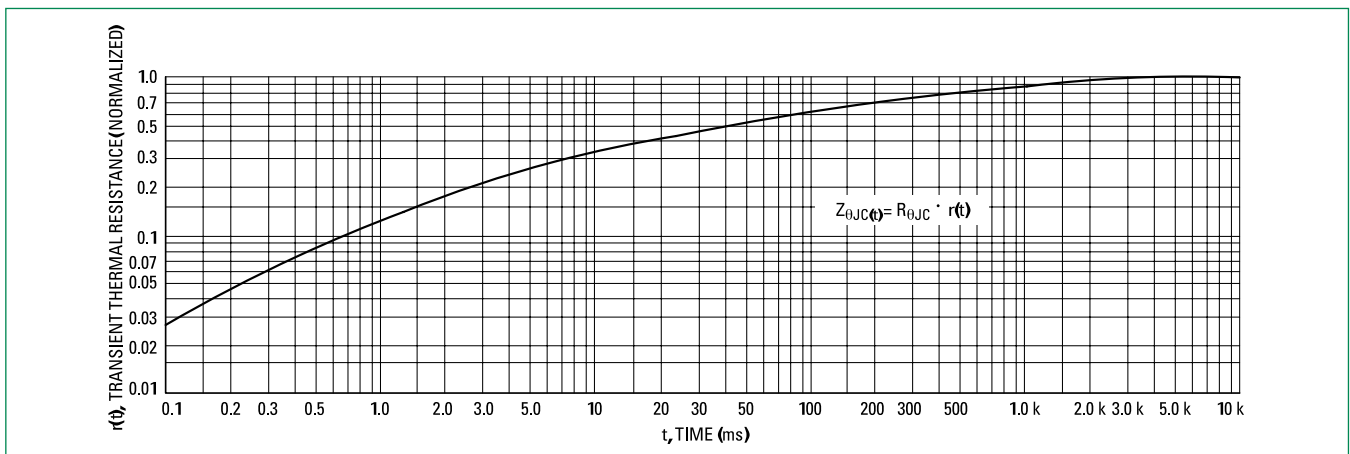

Figure 5. Thermal Response



2N6504 Series

SCRs-25 AMPERES RMS- 50 - 800V

Typical Trigger Characteristics

Figure 6. Typical Gate Trigger Current vs. Junction Temperature

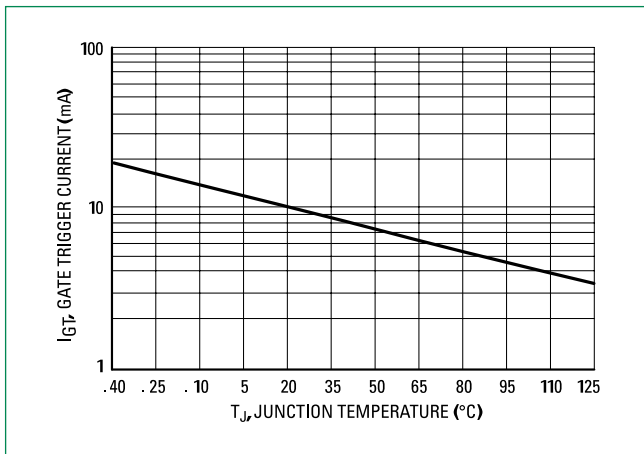

Figure 7. Typical Gate Trigger Voltage vs. Junction Temperature

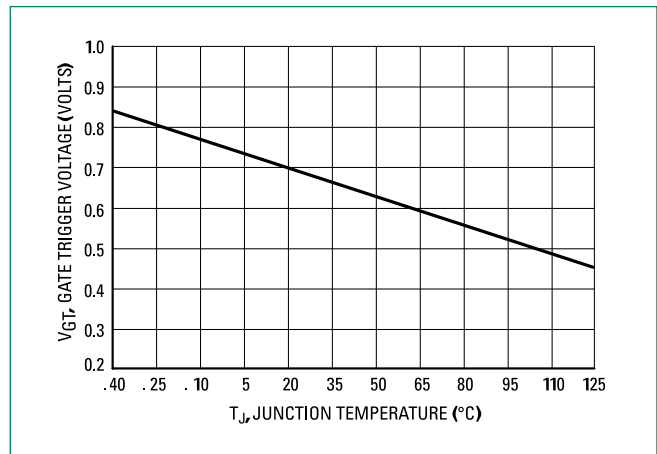
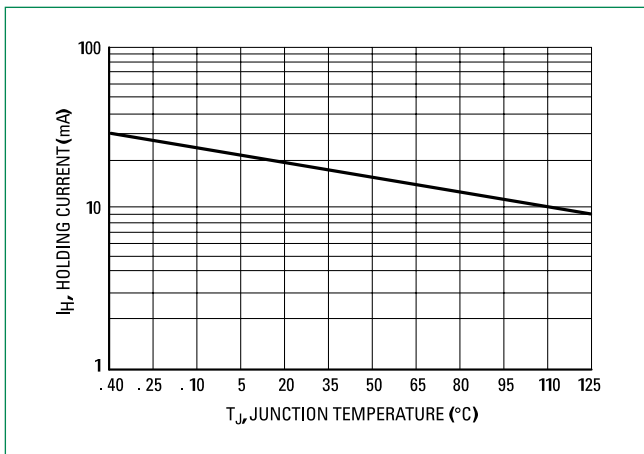

Figure 8. Typical Holding Current vs. Junction Temperature



2N6504 Series

SCRs-25 AMPERES RMS- 50 - 800V

Dimensions

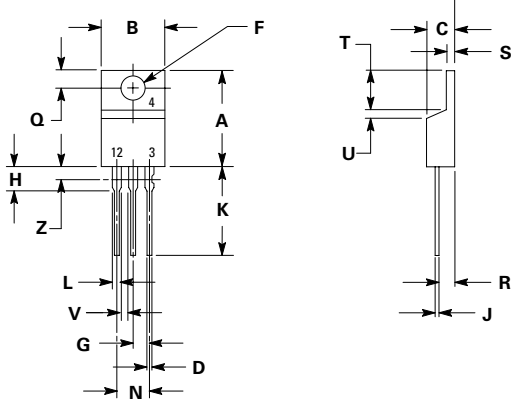

Dim	Inches		Millimeters	
	Min	Max	Min	Max
A	0.590	0.620	14.99	15.75
B	0.380	0.420	9.65	10.67
C	0.178	0.188	4.52	4.78
D	0.025	0.035	0.64	0.89
F	0.142	0.147	3.61	3.73
G	0.095	0.105	2.41	2.67
H	0.110	0.130	2.79	3.30
J	0.018	0.024	0.46	0.61
K	0.540	0.575	13.72	14.61
L	0.060	0.075	1.52	1.91
N	0.195	0.205	4.95	5.21
Q	0.105	0.115	2.67	2.92
R	0.085	0.095	2.16	2.41
S	0.045	0.060	1.14	1.52
T	0.235	0.255	5.97	6.47
U	0.000	0.050	0.00	1.27
V	0.045	—	1.15	—
Z	—	0.080	—	2.04

1. Dimensioning and tolerancing per ansi y14.5m, 1982.
2. Controlling dimension: inch.
3. Dimension z defines a zone where all body and lead irregularities are allowed.

Part Marking System

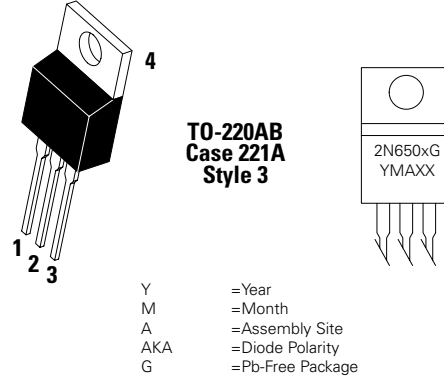

Pin Assignment	
1	Cathode
2	Anode
3	Gate
4	Anode

Ordering Information

Device	Package	Shipping
2N6504	TO-220AB	1000 Units / Box
2N6504G	TO-220AB (Pb-Free)	
2N6505	TO-220AB	
2N6505G	TO-220AB (Pb-Free)	1000 Units / Box
2N6505T	TO-220AB	
2N6505TG	TO-220AB (Pb-Free)	
2N6507	TO-220AB	1000 Units / Box
2N6507G	TO-220AB (Pb-Free)	
2N6507T	TO-220AB	
2N6507TG	TO-220AB (Pb-Free)	1000 Units / Box
2N6508	TO-220AB	
2N6508G	TO-220AB (Pb-Free)	
2N6508TG	TO-220AB	1000 Units / Box
2N6509	TO-220AB (Pb-Free)	
2N6509G	TO-220AB	
2N6509T	TO-220AB (Pb-Free)	1000 Units / Box
2N6509TG	TO-220AB	

Disclaimer Notice - Information furnished is believed to be accurate and reliable. However, users should independently evaluate the suitability of and test each product selected for their own applications. Littelfuse products are not designed for, and may not be used in, all applications. Read complete Disclaimer Notice at <http://www.littelfuse.com/disclaimer-electronics>.

Mouser Electronics

Authorized Distributor

Click to View Pricing, Inventory, Delivery & Lifecycle Information:

[Littelfuse:](#)

[2N6508G](#) [2N6505G](#) [2N6509G](#) [2N6505TG](#) [2N6508TG](#) [2N6504G](#) [2N6509TG](#) [2N6507G](#) [2N6507TG](#)